



ORIGINAL

Petromax
GERMANY

Petromax

HK150 - HK250 - HK350 - HK500



Bedienungsanleitung



User Manual



Manuel de l'utilisateur



Manual de instrucciones



Kullanma kılavuzu



Руководство по эксплуатации



사용자 매뉴얼



取扱説明書



Käyttöohje



Användarmanual

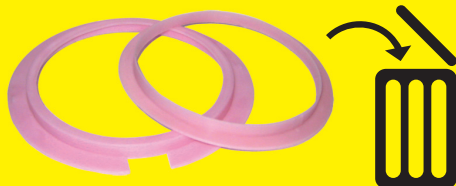

D

Warnhinweis!

Achten Sie bei einer neuen Lampe darauf, die Kunststoff-Transportringe, in welche das Glas eingefasst ist, vor dem Erstbetrieb zu entfernen!

GB

Warning reference!

Before using a new light for the first time, please make sure that you remove the plastic packaging rings around the glass!

F

Avertissement!

Lors d'une première utilisation, il est vivement recommandé d'enlever l'emballage de protection du verre (anneaux en plastique)!

NL

Waarschuwing!

Let er bij een nieuwe lamp op dat u de kunststof transportringen, die om het glas zitten voor gebruik verwijderd!













ORIGINAL

Petromax
GERMANY

Petromax

HK150 - HK250 - HK350 - HK500

	4
	8
	12
	16
	20
	24
	28
	32
	36
	40

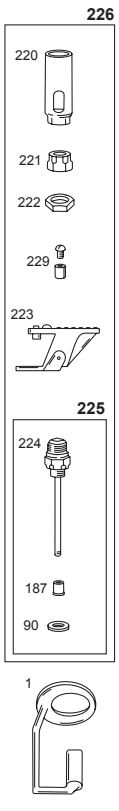
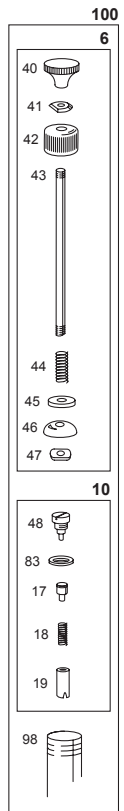
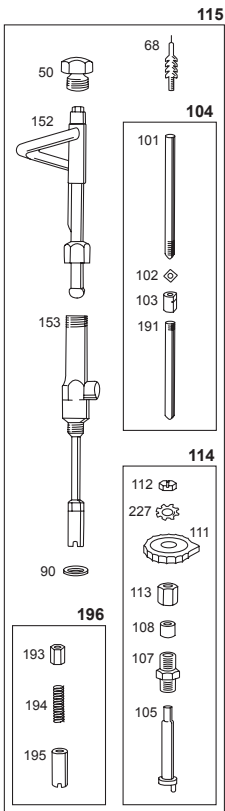
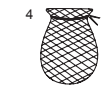
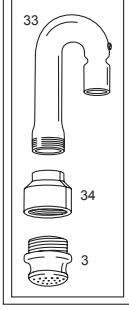
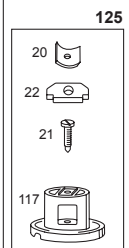
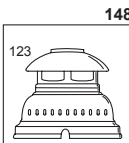
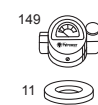
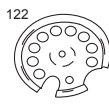
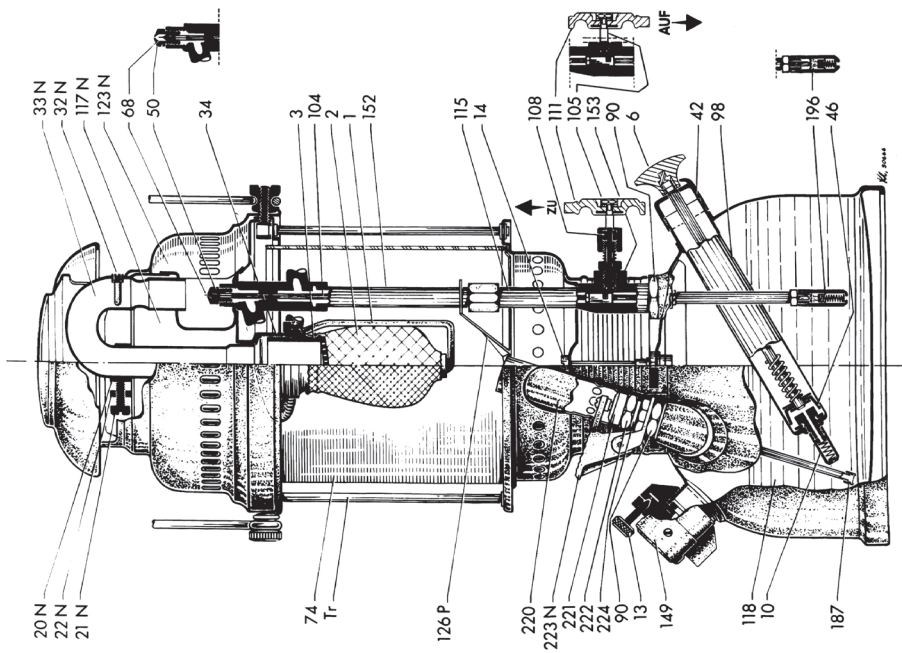

USER MANUAL FOR PETROMAX PRESSURE LAMPS

HK150 - HK250 - HK350 - HK500



Please read these instructions carefully and keep them in a safe place!

SAFETY NOTES AND WARNINGS

- Only use the lamp outdoors. Do not use indoors!
- The lamp must not be used close to objects that are flammable or sensitive to heat.
- Do not place the lamp on delicate surfaces.
- Never leave the lamp unattended while it is in use.
- Only use pure paraffin oil or kerosene. Do not use scented or coloured oils. Recommendation: Petromax Alkan paraffin.
- This lamp is not a toy and it must not be used by children. Keep out of reach of children and animals.
- Do not cover the lamp.
- Risk of burning! Do not touch the lamp above the tank during use or 1 hour after use. After use let it cool down fully.
- Release the pressure completely after each use by opening the bleeder screw.
- Do not add or remove fuel while the lamp is in use.
- Only use original Petromax replacement parts. The warranty expires should other replacement parts be used.
- In case of improper use or misappropriation, we assume no liability.
- Do not stare into the incandescent mantle.
- Do not inhale the smoke emitted by the burning incandescent mantle.

PRODUCT DESCRIPTION

The Petromax is easily the most well-known pressure lamp in the world. It has been widely used for more than 100 years as a weather-resistant and reliable external light source. Depending on the model, it provides a luminous power output of 400, 280, 200 or 120 watts. The brightness level cannot be adjusted. With the appropriate accessories, the lamp can be used for heating or converted in an efficient cooking means.

SCOPE OF DELIVERY

Your Petromax lamp comes with a package that contains the following items:

- 1 x funnel
- 1 x accessories and replacement parts set (6 pieces)
- 1 x spirit can
- 2 x incandescent mantle

PARTS DESCRIPTION

A Petromax lamp is composed of more than 200 individual parts. The figure below shows all main parts. You will find a complete overview of all parts on: www.petromax.de, or contact our Technical Support team for further information.

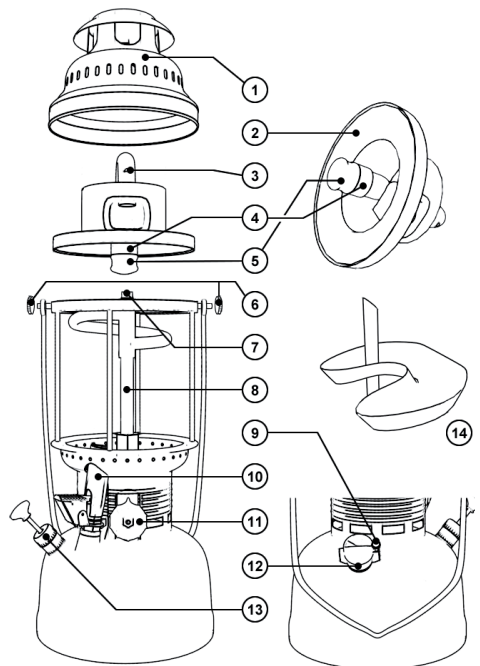

- | | |
|--------------------------|---------------------|
| 1) Hood | 8) Carburettor |
| 2) Inner casing | 9) Bleeder screw |
| 3) Regulating screw | 10) Rapid preheater |
| 4) Mixing chamber | 11) Handwheel |
| 5) Burner | 12) Manometer |
| 6) Knurled nuts | 13) Hand pump |
| 7) Spray nozzle + needle | 14) Preheat cup |

USING THE LAMP

Prior to starting the lamp

- Damaged mantles must be replaced immediately.
- Make sure that needle, spray nozzle, mixing chamber, and burner are properly tightened and connected.

Starting the lamp

- See "Starting: Step by Step".

After starting the lamp

- When the pressure falls below 1 bar, carefully bring pressure to the tank using the hand pump (approx. 2.5 bar).

Extinguishing the lamp

- To extinguish the lamp, release the pressure via the bleeder screw.
- In the case of unpredicted flames development, open the bleeder screw immediately.
- Finish by turning the handwheel upward.

TROUBLESHOOTING

The pump does not work properly.

Pull out the pump plunger, grease the leather seal and gently widen the leather seal (replace it if necessary!). Push the pump plunger back into the cylinder of the pump by turning the pump plunger.

The upper part of the lamp catches fire.

Preheat the lamp for at least 90 seconds using the rapid preheater. When pre-heating with the use of spirit (preheat cup), use at least two full cups of spirit.

The incandescent mantle does not burn properly.

When using the rapid preheater, position the incandescent mantle in a way that it can easily catch fire via the rapid preheater.

The rapid preheater does not ignite/burn properly.

Ensure that there is neither too much nor too little pressure in the tank. The manometer needle should be just below the red line! If necessary, clean the nozzle of the rapid preheater with the cleaning needle included in the replacement parts set.

The lamp flickers or gets darker.

Make sure that there is enough pressure and fuel in the tank. If necessary, rapidly turn the

handwheel 360 degrees to free the spray nozzle of any particles via the needle.

PREHEATING THE LAMP WITH SPIRIT

All current Petromax models come with a preheat cup in addition to a rapid preheater. Preheating with spirit is more gentle on the mantle.

Preheating the lamp through the preheat cup

- Sprinkle the new mantle with spirit.
- Fill the preheat cup with spirit using the spirit can.
- Burn the spirit in the preheat cup and wait until the cup has burned to the point of being empty.
- Again, put spirit in the preheat cup and ignite it.
- Wait until the spirit has almost completely burned out, and then turn the handwheel (with the nose pointing down).

WARRANTY

In the case of normal use, a warranty period of two years will apply to your Petromax pressure lamp from the date of purchase. This does not apply to wearing parts. If your product does not function properly due to damages with the material or manufacturing defects, you are entitled to a warranty repair. Contact your dealer for that purpose.

TECHNICAL SUPPORT

If you have questions regarding the contents of the manual, or if you need additional information, please let us know. You can contact our Technical Support team via email at: service@petromax.de. Further technical advice is available on the Support site at www.petromax.de.

PETROMAX FORUM

You can find useful information and advice to solve problems and to help maintaining your lamp in the free Petromax forum: www.petromax.de/petromaxforum.



STARTING THE LAMP: STEP BY STEP

Before using your Petromax lamp, read the Safety notes and Warnings very carefully.



Do not inhale the smoke emitted by the lamp, its parts, and the mantle!

Do not use indoors!

STEP 1

- Loosen the knurled nuts.
- Remove the hood and the inner casing.

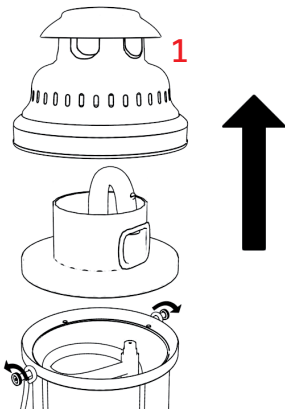

STEP 2

- Tie the mantle to the burner bead with a double knot. Do not tie the mantle to the mixing chamber!
- Trim loose threads as short as possible.

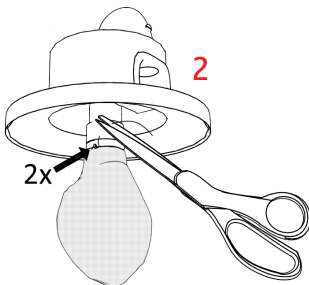

STEP 3

- Install the inner casing and the hood, and make sure that the regulating screw at the mixing tube is visible (not for HK150).
- Tighten the knurled nuts by hand.

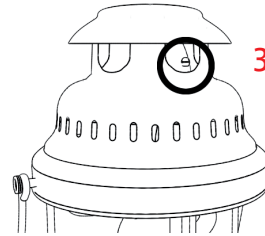

STEP 4

- Unscrew the manometer.
- Add fuel to the tank (see Safety Notes and Warnings).

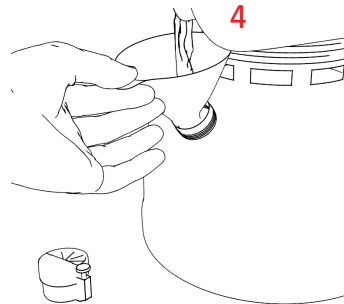

STEP 5

- Make sure that the nose is pointing upward.
- Screw the manometer onto the tank by hand.

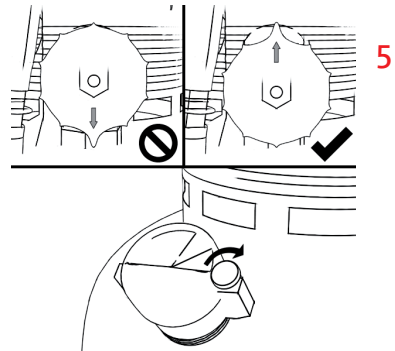

- Make sure that the bleeder screw on the manometer is properly tightened.

STEP 6

- Unlock the pump by turning the pump knob.
- Repeatedly push the hand pump's plunger until the manometer reads approx. 1.5 bar.

STEP 7A

- Push the lever of the rapid preheater downward, and immediately ignite the flowing fuel with a lighter.

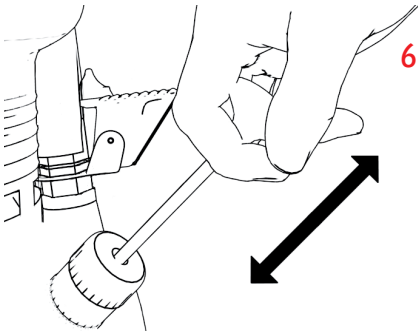

STEP 7B (with new mantle only)

- With a newly installed mantle, close the lever after approx. 10 seconds. Let the mantle burn down completely until it appears dyed grey, and make sure that the mantle has no black bits.

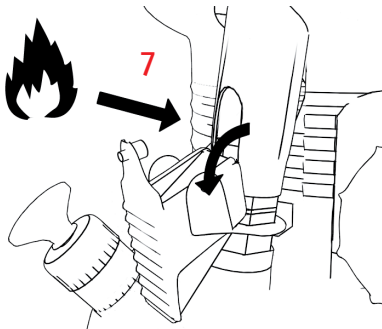

- Finish by pushing the lever downward and immediately ignite the flowing fuel.

STEP 8

- Repeatedly push the hand pump's plunger to keep the pressure at 1.5 bar.
- The rapid preheater will now preheat the carburettor. It must be preheated for at least 90 seconds.

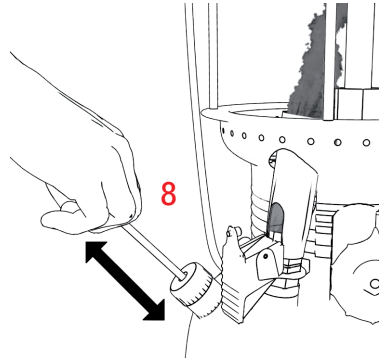

STEP 9

- After 90 seconds, turn the handwheel nose down.
- As soon as the lamp lights, close the lever of the rapid preheater.
- Bring the lamp to operating pressure (2.5 bar).

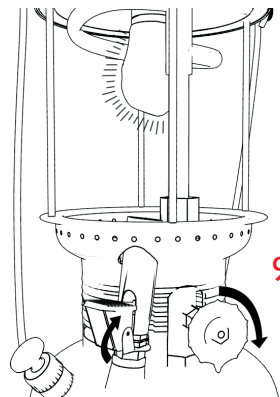



ORIGINAL

Petromax
GERMANY

Petromax GmbH
Sudenburger Wuhne 61
39116 Magdeburg
Germany

Telefon: +49 (0)391 / 400 26 05

Fax: +49 (0)391 / 400 26 06

E-Mail: info@petromax.de

Internet: www.petromax.de

Copyright © 2011 Petromax GmbH. Alle Rechte vorbehalten.

Petromax und die Drachenmarke sind eingetragene Marken. Kein Teil dieser Anleitung darf in irgendeiner Form ohne schriftliche Genehmigung reproduziert oder unter Verwendung elektronischer Systeme verarbeitet, vervielfältigt oder verbreitet werden.

Printed in Germany